



The Razer Orbweaver is the world's first mechanical gaming keypad that binds every command and skill from any FPS, RTS, and MMORPG to 30 fully programmable keys including an 8-way thumb-pad at your fingertips. With that many keys within quick reach, and requiring only 50g of force to actuate, you'll be able to react to any challenge at an unrivaled speed. The distinctive tactile feedback from the mechanical keys also provides a whole new feel to your gaming experience, and for maximum comfort, the Razer Orbweaver features adjustable hand size, thumb, and palm-rest modules to provide the most ergonomic form factor, just the way you like it.

With the Razer Orbweaver, get complete control for complete victory.

CONTENTS

1. PACKAGE CONTENTS / SYSTEM REQUIREMENTS	3
2. REGISTRATION / TECHNICAL SUPPORT	4
3. TECHNICAL SPECIFICATIONS	5
4. DEVICE LAYOUT	6
5. USING YOUR RAZER ORBWEAVER	7
6. INSTALLING YOUR RAZER ORBWEAVER	11
7. CONFIGURING YOUR RAZER ORBWEAVER.....	12
8. SAFETY AND MAINTENANCE.....	28
9. LEGALESE	30

1. PACKAGE CONTENTS / SYSTEM REQUIREMENTS

PACKAGE CONTENTS

- Razer Orbweaver Elite Mechanical Gaming Keypad
- Quick Start Guide

SYSTEM REQUIREMENTS

- PC / Mac with a free USB port
- Windows® 8 / Windows® 7 / Windows Vista® / Windows® XP (32-bit) / Mac OS X (10.7-10.9)
- Internet connection
- 200MB of free hard disk space

2. REGISTRATION / TECHNICAL SUPPORT

REGISTRATION

Sign up now for a Razer Synapse account to get real-time information on your product's warranty status. To learn more about Razer Synapse and all its features, visit www.razerzone.com/synapse.

If you are already a Razer Synapse user, register your product by clicking on your email address at the Razer Synapse application and select *Warranty Status* from the dropdown list.

To register your product online, visit www.razerzone.com/registration. Please note that you will not be able to view your warranty status if you register via the website.

TECHNICAL SUPPORT

What you'll get:

- 1 year limited manufacturer's warranty.
- Free online technical support at www.razersupport.com.

3. TECHNICAL SPECIFICATIONS

TECHNICAL SPECIFICATIONS

- Full mechanical keys with 50g actuation force
- 30 fully programmable keys including an 8-way thumb-pad
- Adjustable hand , thumb, and palm-rests modules for maximum comfort
- Instantaneous switching between 8 keymaps
- Unlimited macro lengths
- Unlimited game profiles
- Backlit keypad for total control even in dark conditions
- Synapse enabled

APPROXIMATE SIZE & WEIGHT

- Width 202 mm / 7.95"
- Height 154mm / 6.06"
- Depth 55 mm / 2.17"
- Weight 300 g / 0.66 lbs

4. DEVICE LAYOUT

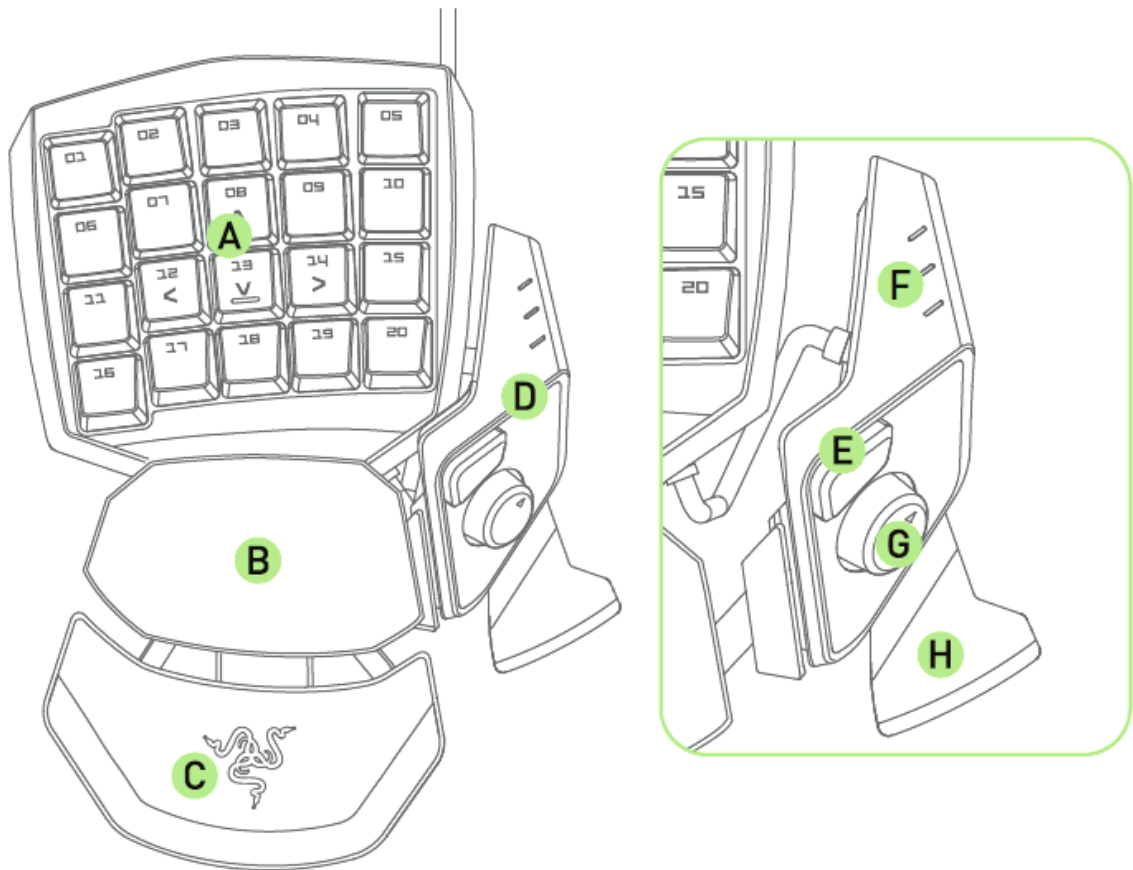

- A. 20 Fully Programmable Mechanical Backlit Keys
- B. Swiveling Palm Rest
- C. Adjustable Soft-Touch Wrist Pad
- D. Adjustable Thumb Module
- E. Hyperresponse Thumb Key
- F. Keymap Indicator
- G. Programmable 8-Way Directional Thumb Pad
- H. Spacebar Actuator

5. USING YOUR RAZER ORBWEAVER

ADJUSTING THE THUMB MODULE

1. Press and hold the button to unlock the thumb module.

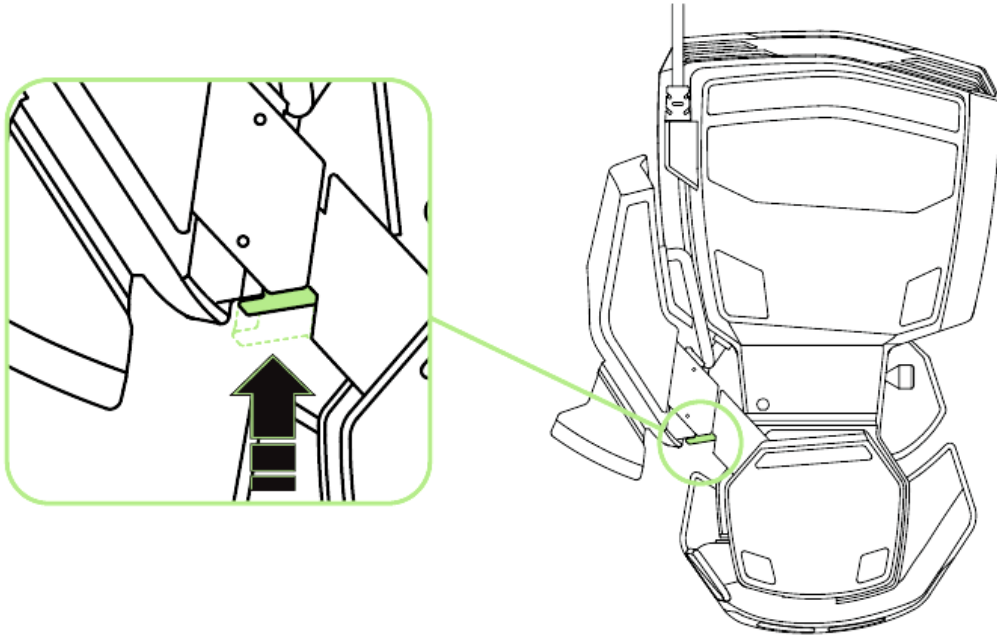

2. Slide the thumb module diagonally to adjust.

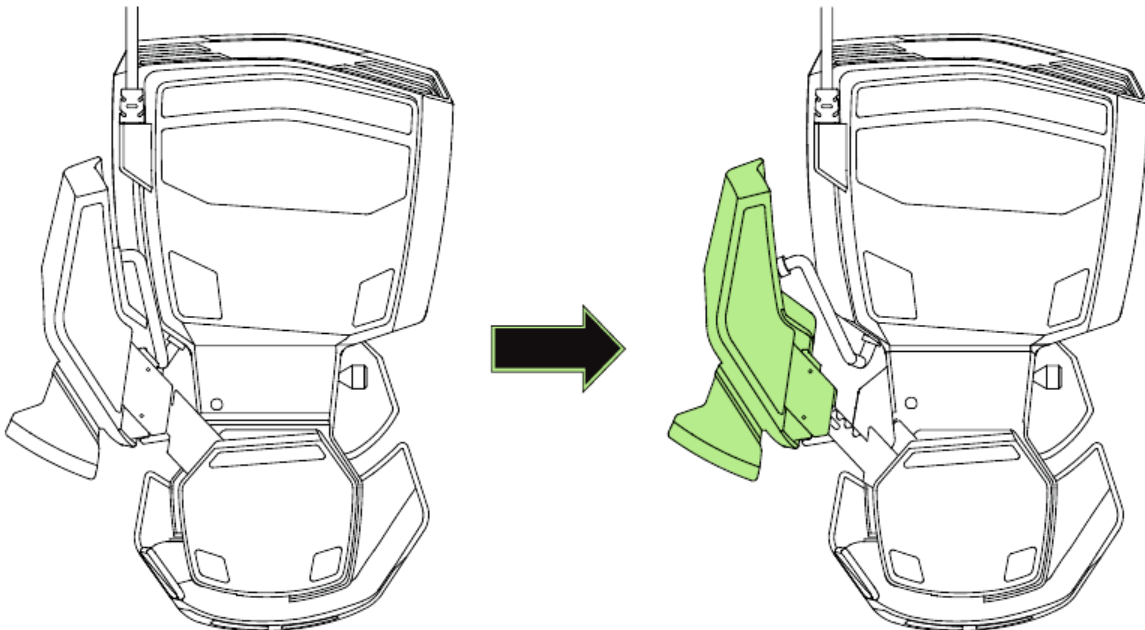

3. Release the button to lock the thumb module into position.

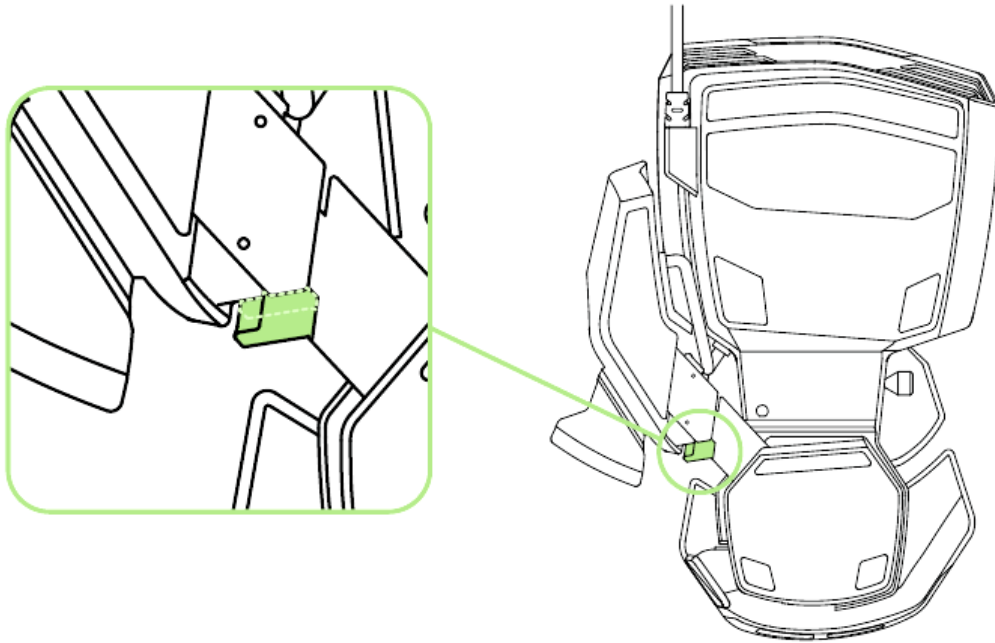

ADJUSTING THE OVERALL LENGTH

1. Press and hold the lever to unlock the bottom half of the Razer Orbweaver.

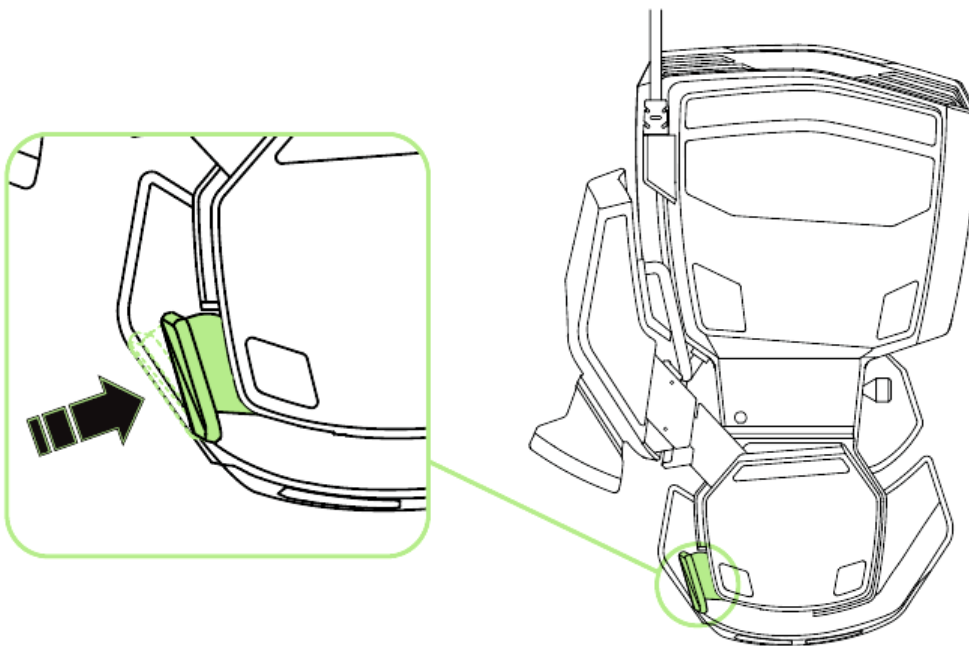

2. Slide the bottom half of the Razer Orbweaver vertically to adjust.

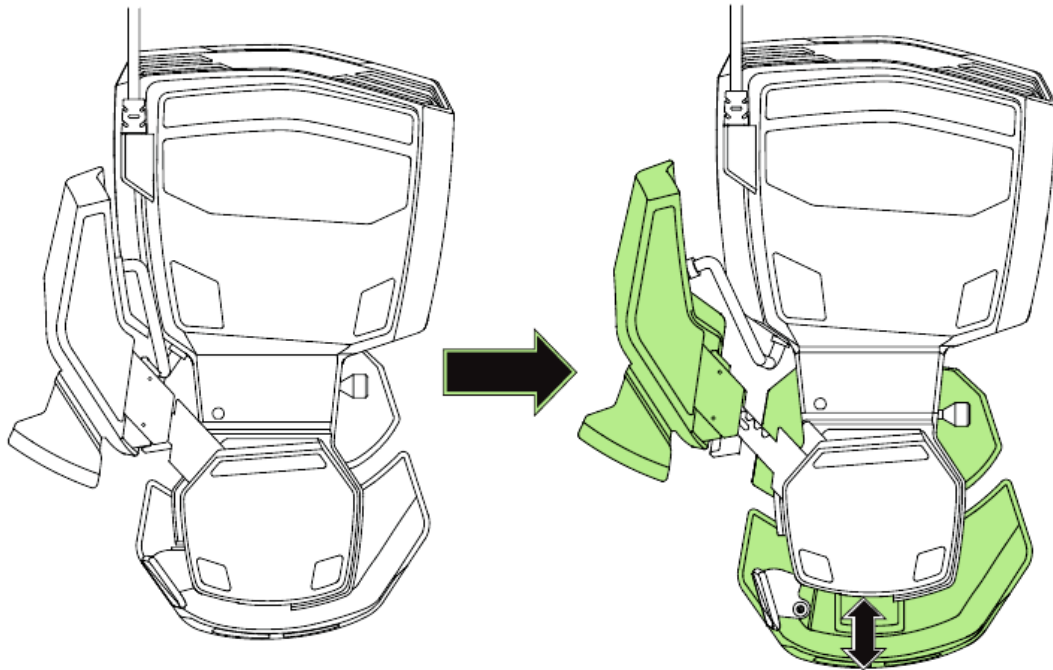

3. Release the lever to lock the bottom half into position.

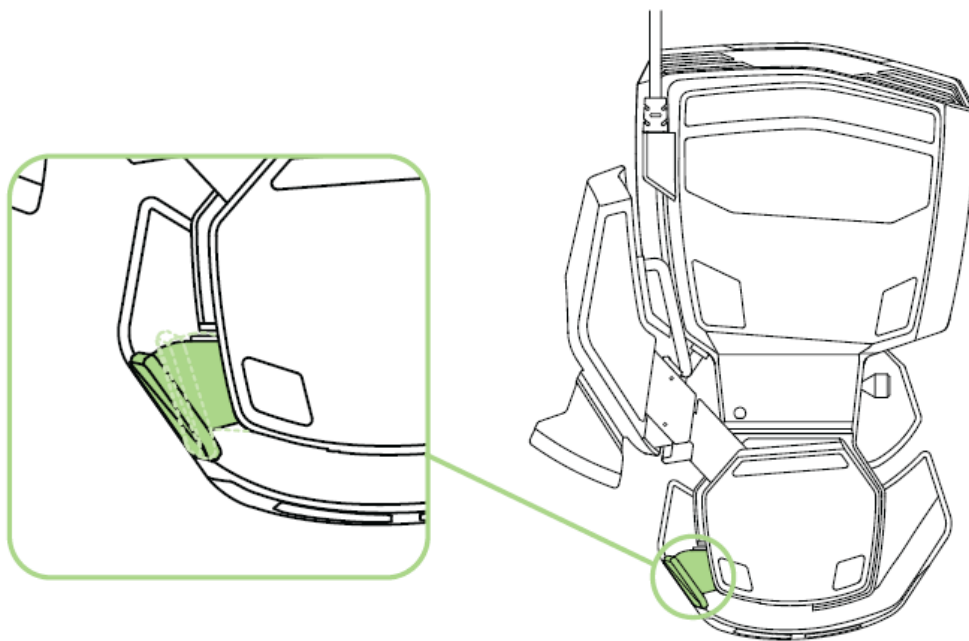

ADJUSTING THE PALM REST

Free-Play Mode

Pull the locking pin to allow the palm rest to swing.

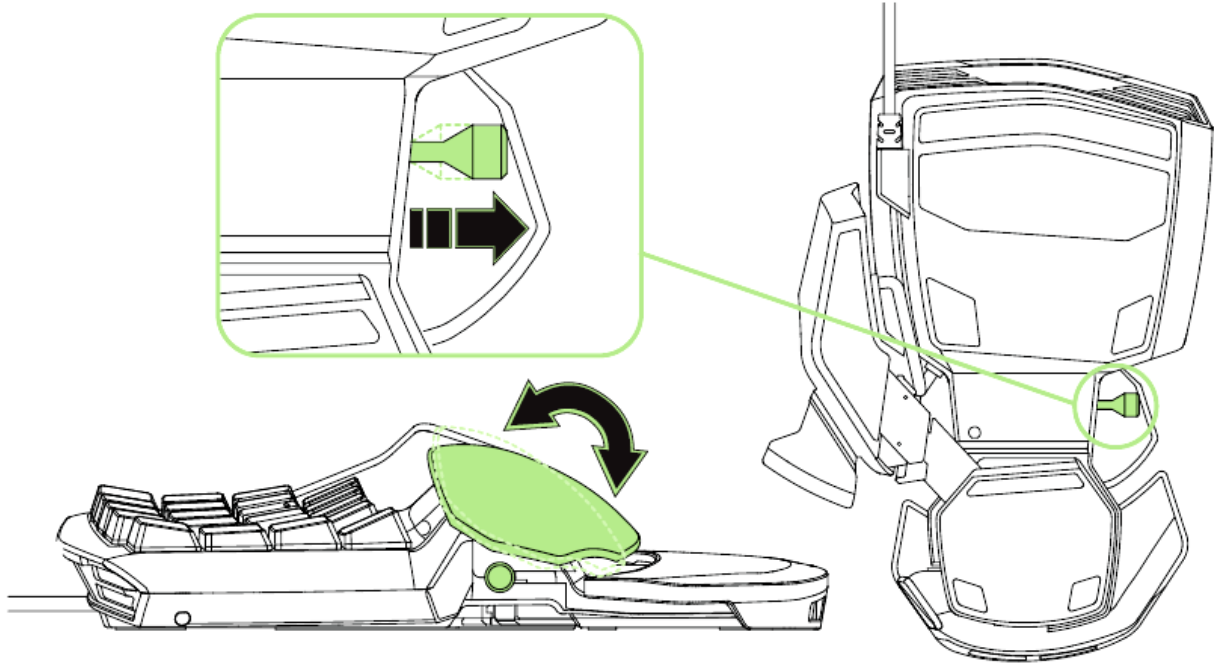

Locked Mode

Push the locking pin to secure the palm rest to its current position.

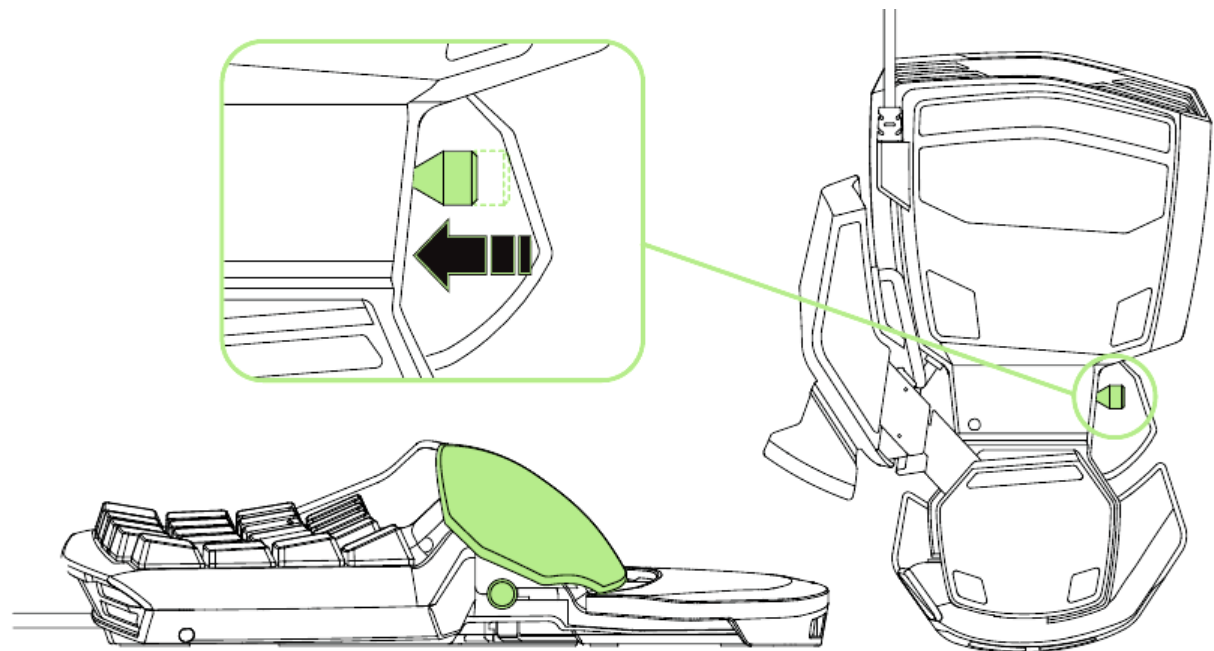

6. INSTALLING YOUR RAZER ORBWEAVER

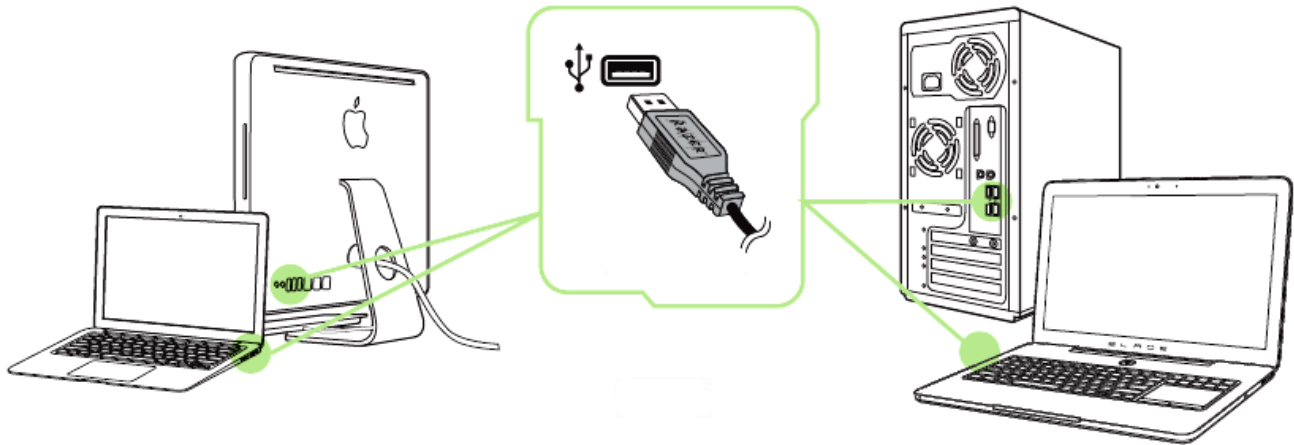

Step 1: Connect your Razer device to the USB port of your computer.

Step 2: Install Razer Synapse when prompted* or download the installer from www.razerzone.com/synapse.

Step 3: Create your Razer ID or login to Synapse with your existing Razer ID.

*Applicable for Windows 8 or later.

7. CONFIGURING YOUR RAZER ORBWEAVER

Disclaimer: The features listed here require you to log in to Razer Synapse. These features are also subject to change based on the current software version and your Operating System.

KEYPAD TAB

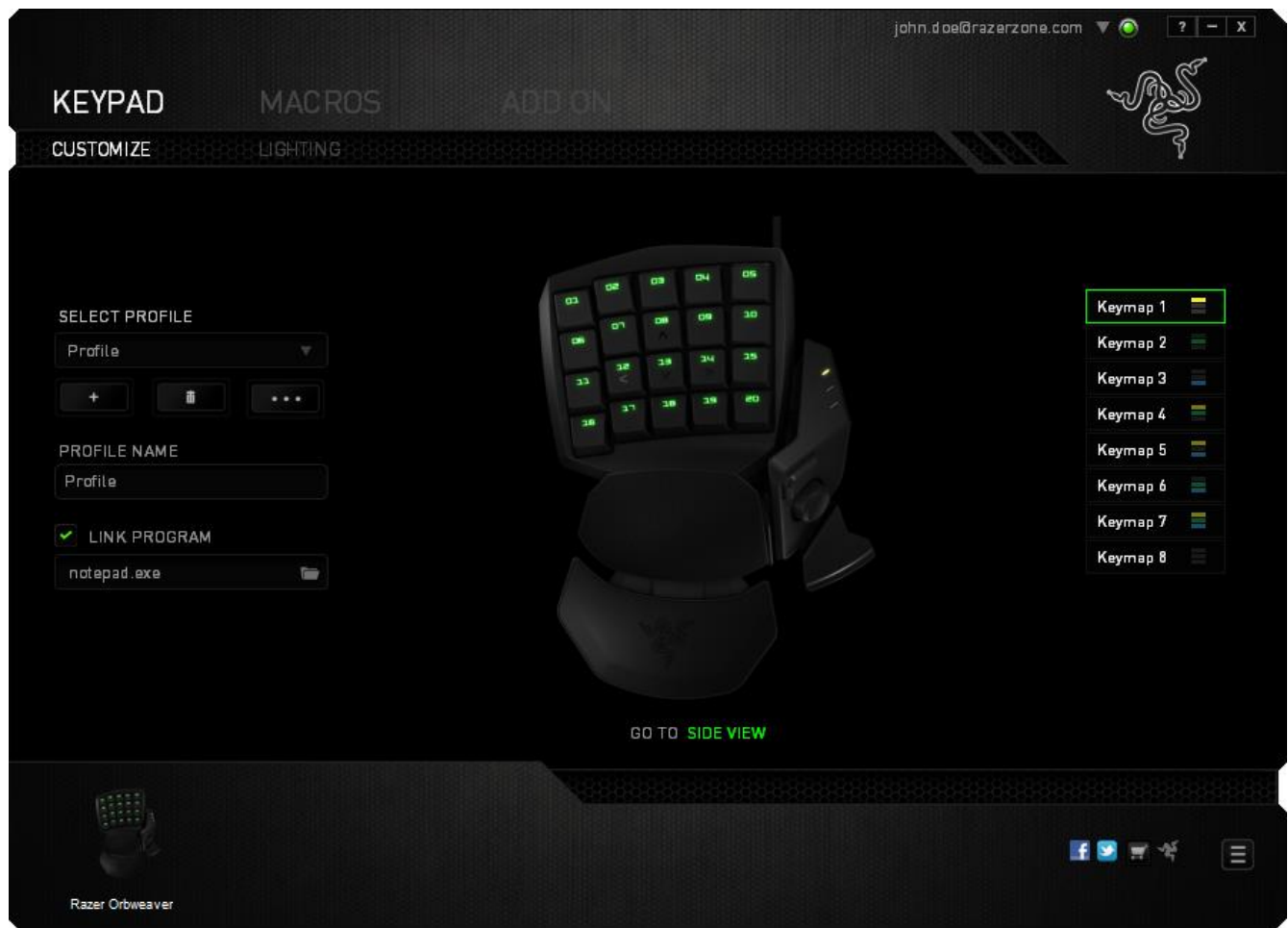

The Keypad Tab is your default tab when you first install Razer Synapse. This tab allows you to customize your device's profiles, key assignments and lighting.

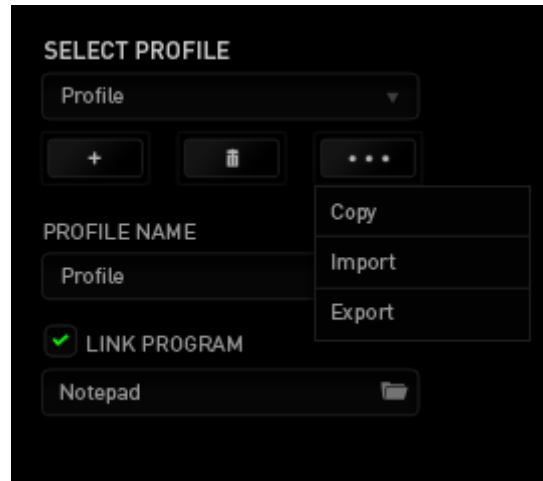

Profiles

A Profile is a convenient way of organizing all your custom settings and you can have an infinite number of profiles at your disposal. Any changes made within each tab are automatically saved to the current profile and stored into the cloud servers.



You can create a new profile by clicking the  button or delete the current profile by clicking the  button. The  button allows you to Copy, Import, and Export profiles.

Your current profile by default is named “*Profile*” however; you can rename it by typing on the text field below *PROFILE NAME*.

Each profile can be set to automatically activate when you run a program or application through the use of the *LINK PROGRAM* option.

Keymaps

Keymaps are especially useful for games which require different play-styles for different character classes. With Keymaps, you can have up to 8 sets of key assignments per profile. Each keymap has an equivalent color on the Keymap Indicator to make it easier to check your current keymap.

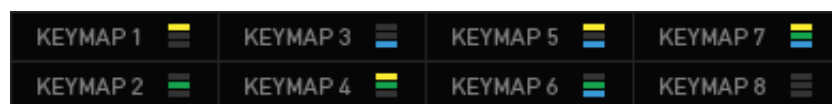

Customize Tab

The Customize Tab is where you can modify the basic functionalities of your device such as key assignments to suit your gaming needs. The changes made in this tab are automatically saved to your current profile.

Top View

The Top View is where you can customize the 20 fully programmable keys.

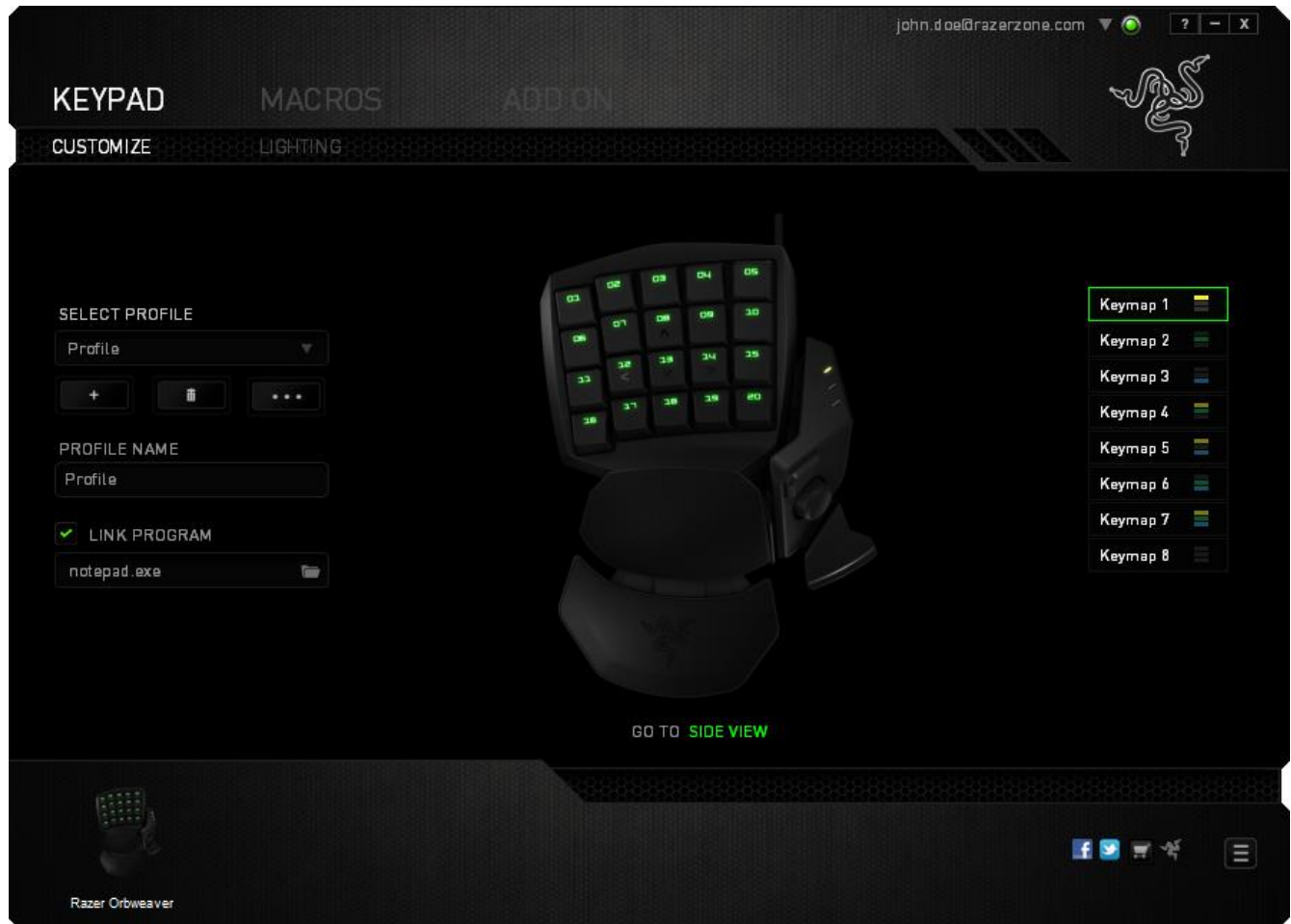

Side View

The Side View is where you can customize the Thumb Key, the Directional Thumb Pad and the Spacebar Actuator.

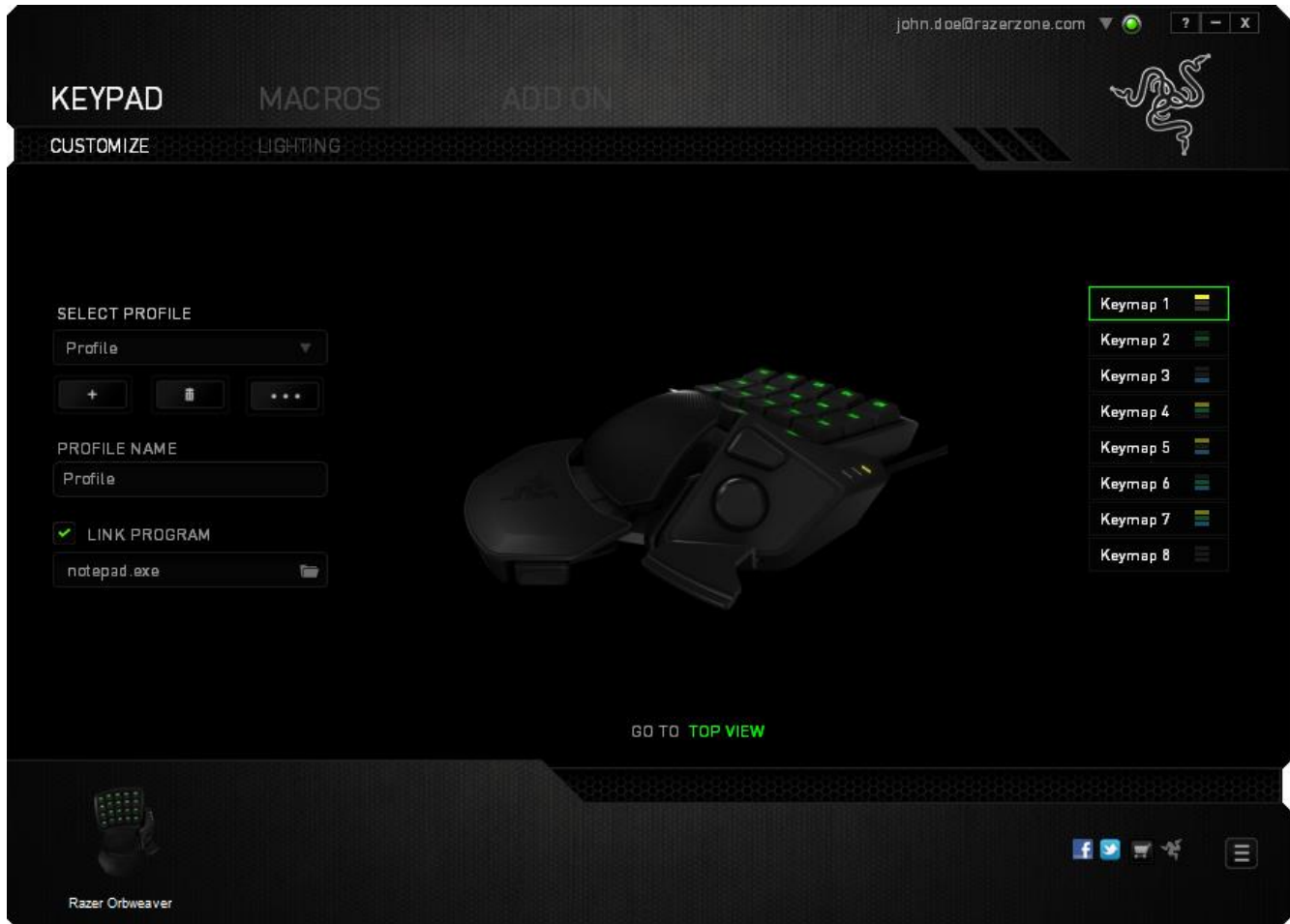

Key Assignment Menu

Initially, each key is set to *DEFAULT*. However, you may change the function of this key by clicking the desired key to access the Key Assignment Menu.

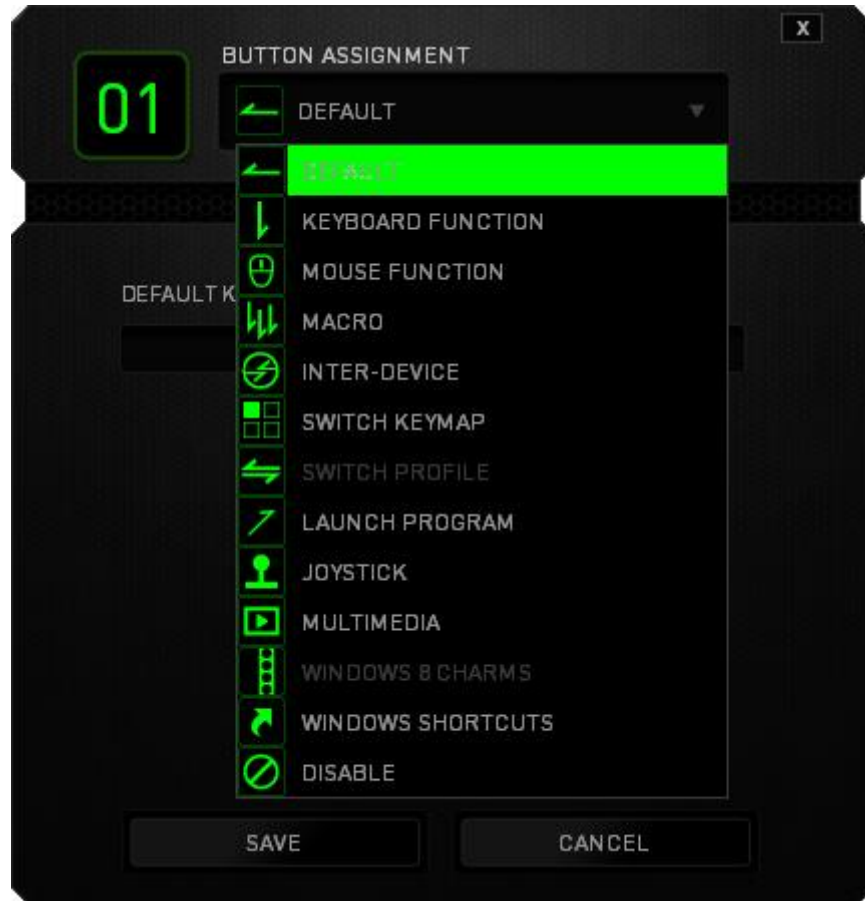

Listed below are the customization options and their description.



Default

This option enables you to return the key to its original function. To choose the *DEFAULT*, simply select it from the Key Assignment Menu.



Keyboard Function

This option enables you to change any key into another keyboard function. To choose a keyboard function, select *KEYBOARD FUNCTION* from the Key Assignment Menu and enter the key you wish to use on the given field below. You may also include modifier keys such as *Ctrl*, *Shift*, *Alt* or any of those combinations.



Mouse Function

This option allows you to change any key into a mouse button function. To choose a mouse function, select *MOUSE FUNCTION* from the Key Assignment Menu and an *ASSIGN BUTTON* submenu will appear.

Listed below are the functions which you can choose from the Assign Button submenu:

Left Click	- Performs a left mouse click using the assigned button.
Right Click	- Performs a right mouse click using the assigned button.
Scroll Click	- Activates the universal scrolling function.
Double Click	- Performs a double left click using the assigned button.
Mouse Button 4	- Performs a “Backward” command for most internet browsers.
Mouse Button 5	- Performs a “Forward” command for most internet browsers.
Scroll Up	- Performs a “Scroll Up” command using the assigned button.
Scroll Down	- Performs a “Scroll Down” command using the assigned button.
Scroll Left	- Performs a “Scroll Left” command using the assigned button.
Scroll Right	- Performs a “Scroll Right” command using the assigned button.



Macro

A Macro is a prerecorded sequence of keystrokes and button presses that is executed with precise timing. By setting a key to Macro, you can conveniently execute a chain of commands. When you select this option from the Key Assignment Menu, a submenu will appear which allows you to choose a prerecorded macro command. See the **Macros Tab** to learn more about creating Macro commands.



Inter-device

Inter-device allows you to change the functionality of other Razer Synapse-enabled devices. Some of these functionalities are device-specific such as using your Razer gaming keyboard to change the Sensitivity Stage of your Razer gaming mouse. When you select Inter-device from the Key Assignment Menu, a sub-menu will appear.

DEVICE TO LINK allows you to choose which currently connected Razer device can be linked while *FUNCTION* allows you to choose which functionality you want to use for the linked device.



Switch Keymap

The Switch Keymap allows you to easily swap key assignments with a press of a key. When you select Switch Keymap from the Key Assignment Menu, a submenu will appear wherein you can choose which keymap to use. The LED on the thumb module will automatically change color to correspond with the keymap.



Switch Profile

The Switch Profile enables you to change profiles on the fly and immediately load all your pre-configured settings. When you select Switch Profile from the Key Assignment Menu, a sub-menu will appear that will allow you to choose which profile to use. An on-screen display will automatically appear whenever you switch profiles.



Launch Program

Launch Program allows you to launch a program or a website using the assigned key. When you select Launch Program from the Key Assignment Menu, two options will appear which allow you to search for the specific program you want to open or write the address of the website you want to visit.



Joystick Function

With this option you can change the functionality of any key into a joystick button or an analog stick direction. To choose a joystick function, select *JOYSTICK FUNCTION* from the Key Assignment Menu and an *ASSIGN BUTTON* submenu will appear.



Multimedia Function

This option allows you to bind multimedia playback controls to your device. After selecting Multimedia Function, a submenu will appear. Listed below are the multimedia playback controls you can choose from the submenu:

- Volume Down - Decreases the audio output.
- Volume Up - Increases the audio output.
- Mute Volume - Mutes the audio.
- Mic Volume Up - Increases the microphone volume.
- Mic Volume Down - Decreases the microphone volume.
- Mute Mic - Mutes the microphone.
- Mute All - Mute both microphone and audio output.
- Play / Pause - Play, pause, or resume playback of the current media.
- Previous Track - Play the previous track.
- Next Track - Play the next track.



Windows 8 Charms

This option enables you to assign the key into an Operating System shortcut command. For more information please visit: <http://windows.microsoft.com/en-us/windows-8/getting-around-tutorial>



Windows Shortcuts

This option enables you to assign the key into an Operating System shortcut command. For more information please visit: <http://support.microsoft.com/kb/126449>



Disable

This option renders the assigned key unusable. Use Disable if you do not want to use the key or if it interferes with your gaming.

Lighting Tab

The Lighting Tab allows you to adjust the backlight by using the *BRIGHTNESS* slider or by using the *PULSATE* option.





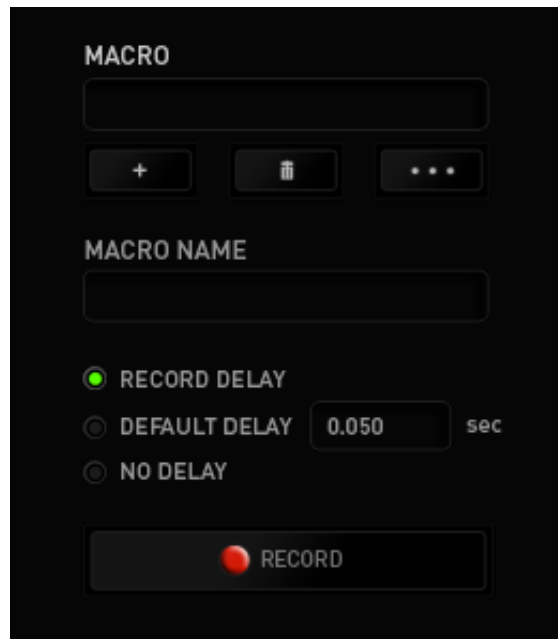

This tab also allows you to turn off the backlighting whenever your screen enters sleep mode.

MACROS TAB

The Macros Tab allows you to create a series of precise keystrokes and button presses. This tab also allows you to have numerous macros and extremely long macro commands at your disposal.



The Macro section works similarly to Profile wherein you can rename a macro by typing on the field below *MACRO NAME*. There are also other options available in the macro section such as creating a new macro by clicking the  button and deleting the current macro by clicking the  button. The  button allows you to Copy, Import, and Export macros.

To create a macro command, simply click the  button and all your keystrokes and button presses will automatically register on the macro screen. When you are done recording your macro commands, click on the  button to end the session.





The Macro section allows you to input the delay in-between commands. In *RECORD DELAY* the delay in-between commands are registered as how it is entered. The *DEFAULT DELAY* uses a predefined time (expressed in seconds) as the delay. And *NO DELAY* omits all the pauses in-between keystrokes and button presses.



Note: You may use up to three decimal places when inserting values on the seconds (sec) field.

Once you have recorded a macro, you may edit the commands you have entered by selecting each command on the macro screen. Each keystroke or button press is arranged sequentially with the first command shown at the top of the screen.





The  button allows you to edit a particular command and the  button enables you to delete a command. The  and  buttons gives you the option to move the command up or down.

The  button allows you to put in additional keystrokes, button presses or time delays either before or after the selected command.

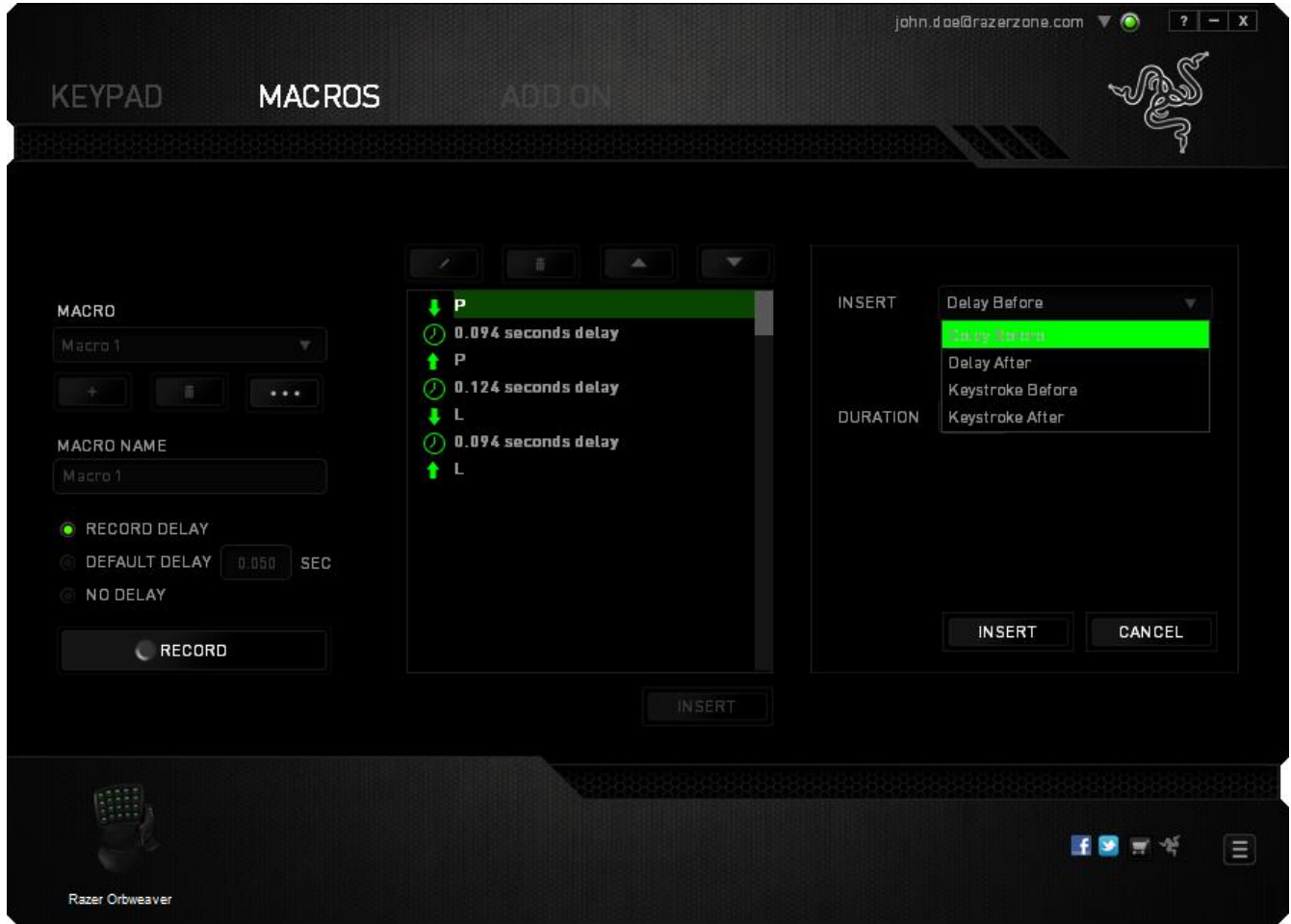
Once you have pressed the **INSERT** button, a new display window will appear beside the list of macro commands. The dropdown menu on this window allows you to choose a keystroke or a delay to be added in before or after the highlighted macro command.

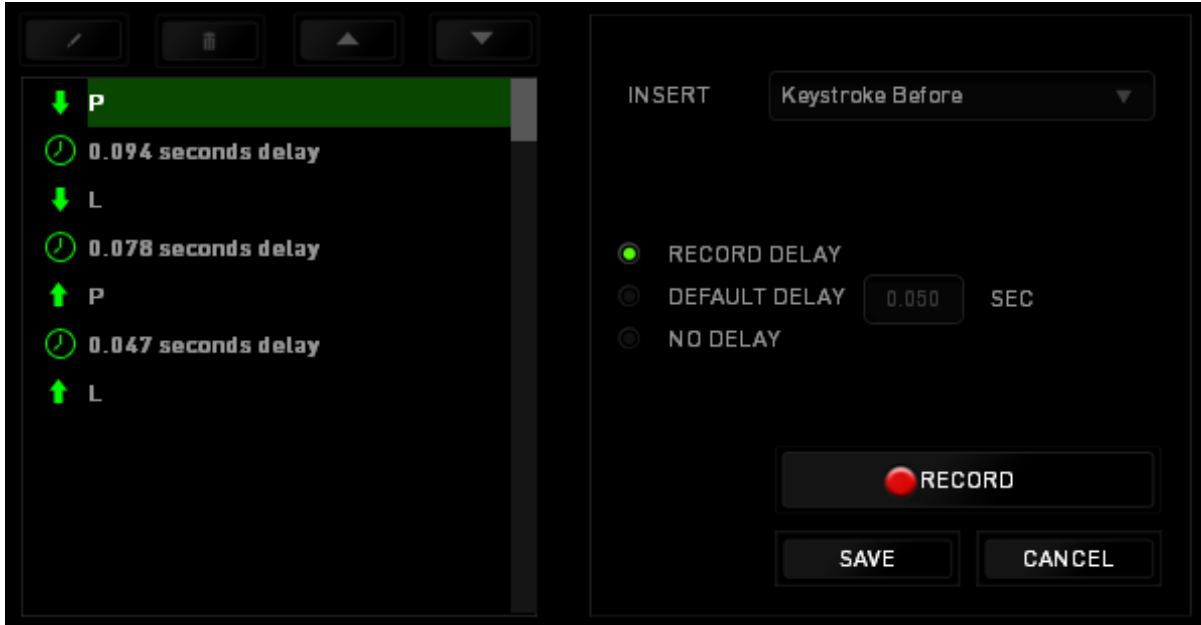



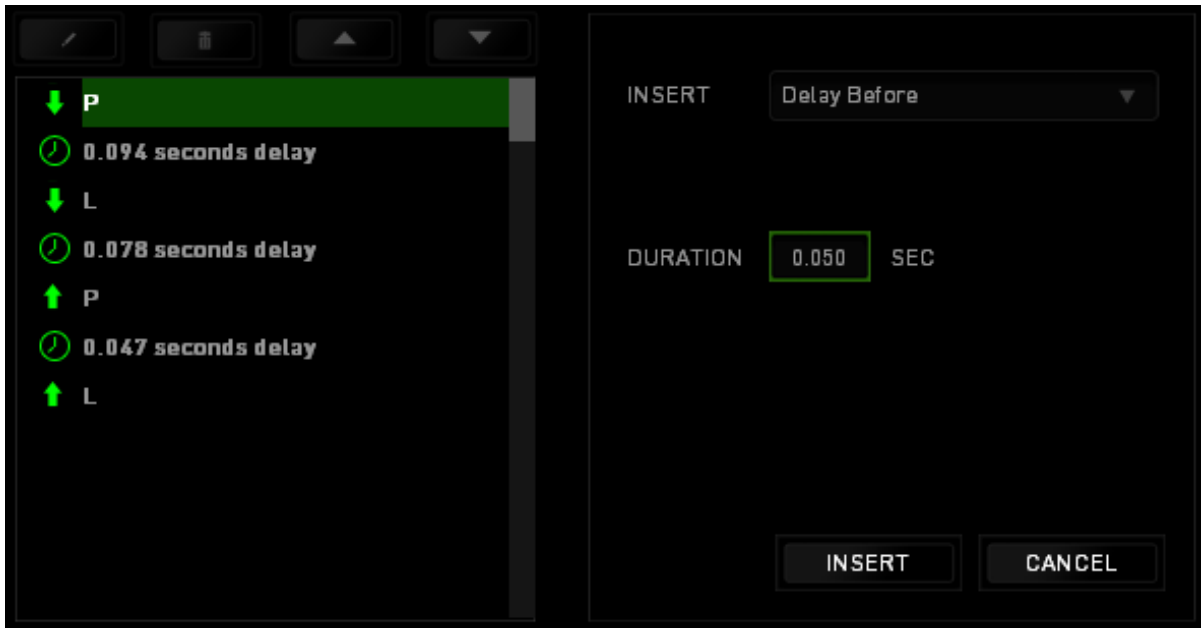

You may add in a new set of macro commands by clicking the  button on the keystroke menu; or input time delays on the duration field using the delay menu.

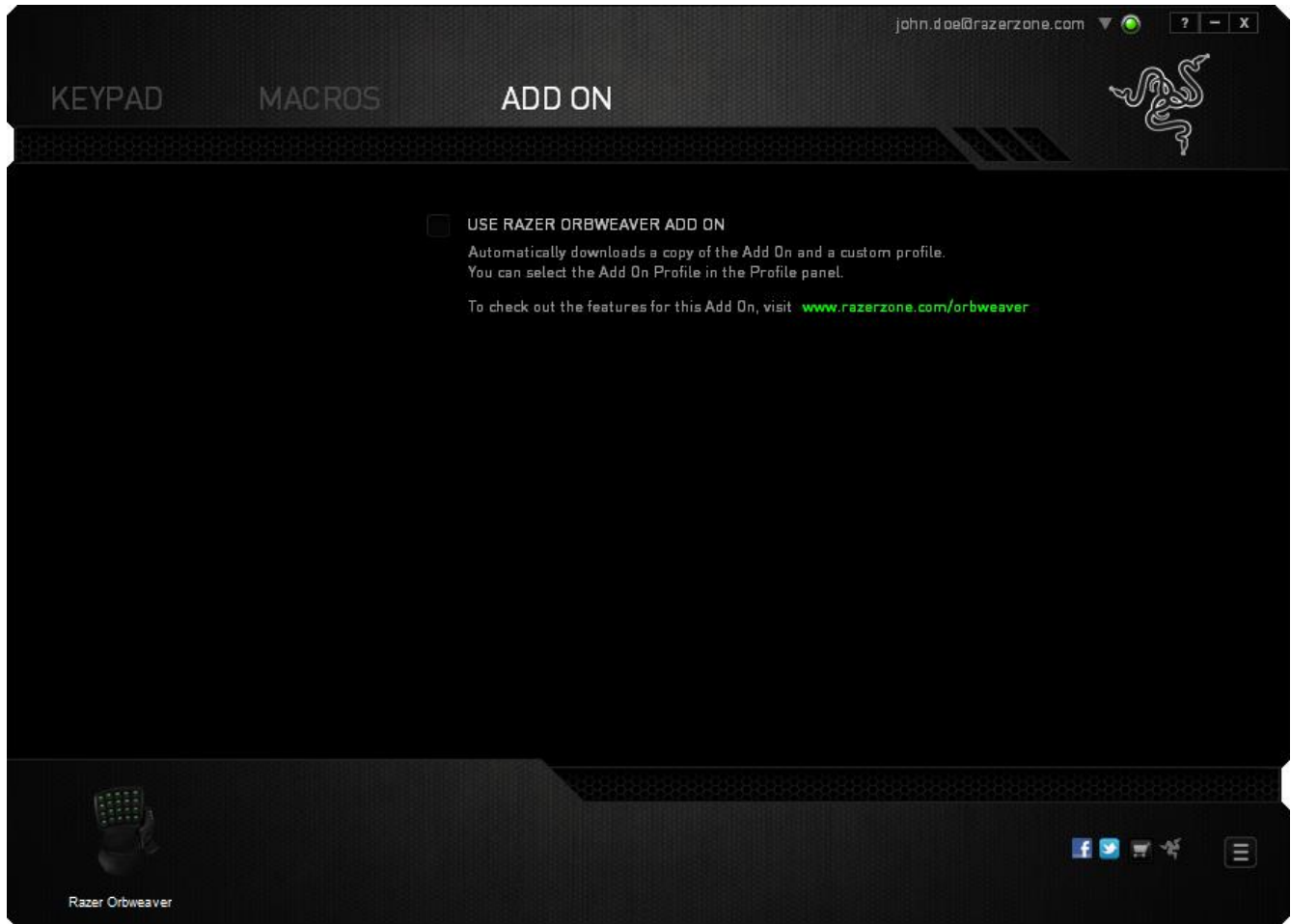

ADD ON TAB

The Add On Tab expands your device's usability by adding game-specific settings such as a custom interface. To start using Razer Add Ons you must first enable the **USE RAZER ORBWEAVER ADD ON** option.



Next, search for the game program or game application using the  button. Finally, select your user account for the game by choosing it on the dropdown menu beside Sync Account.

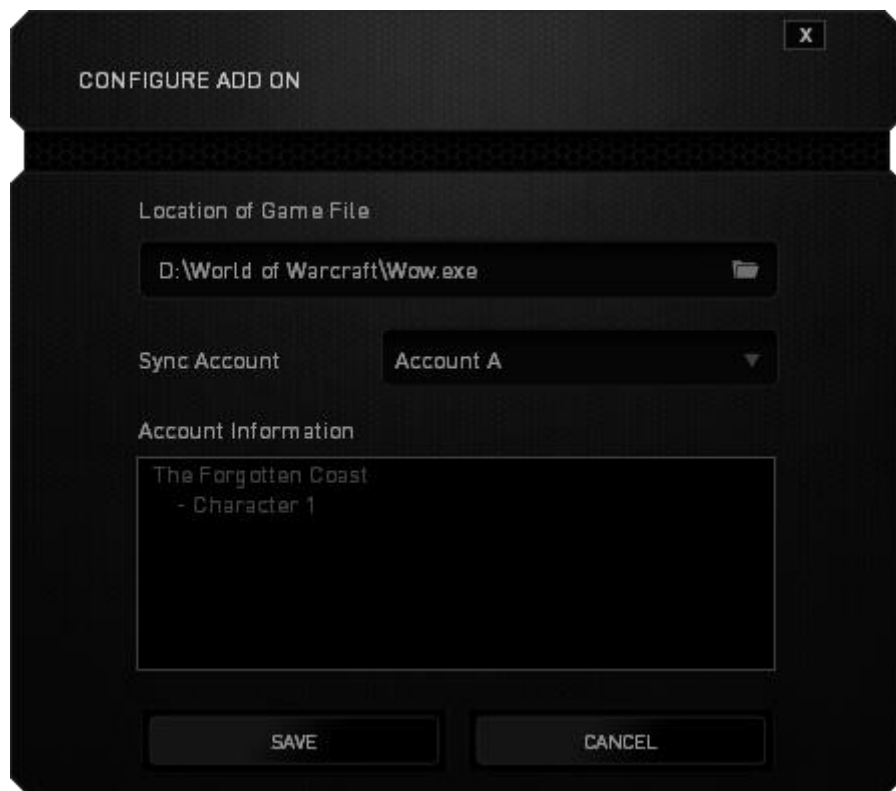

The Account Information screen will show you all the relevant information regarding your user account.

8. SAFETY AND MAINTENANCE

SAFETY GUIDELINES

In order to achieve maximum safety while using your Razer Orbweaver, we suggest that you adopt the following guidelines:

1. Should you have trouble operating the device properly and troubleshooting does not work, unplug the device and contact the Razer hotline or go to www.razersupport.com for support. Do not attempt to service or fix the device yourself at any time.
2. Do not take apart the device (doing so will void your warranty) and do not attempt to operate it under abnormal current loads.
3. Keep the device away from liquid, humidity or moisture. Operate the device only within the specific temperature range of 0°C (32°F) to 40°C (104°F). Should the temperature exceed this range, unplug and switch off the device in order to let the temperature stabilize to an optimal level.

COMFORT

Research has shown that long periods of repetitive motion, improper positioning of your computer peripherals, incorrect body position, and poor habits may be associated with physical discomfort and injury to nerves, tendons, and muscles. Below are some guidelines to avoid injury and ensure optimum comfort while using your Razer Orbweaver.

1. Position your keypad and monitor directly in front of you with your mouse next to it. Place your elbows next to your side, not too far away and your keyboard within easy reach.
2. Adjust the height of your chair and table so that the keypad and mouse are at or below elbow height.
3. Keep your feet well supported, posture straight and your shoulders relaxed.

4. During gameplay, relax your wrist and keep it straight. If you do the same tasks with your hands repeatedly, try not to bend, extend or twist your hands for long periods.
5. Do not rest your wrists on hard surfaces for long periods. Use a wrist rest to support your wrist while gaming.
6. Customize the keys on your keypad to suit your style of gaming in order to minimize repetitive or awkward motions while gaming.
7. Do not sit in the same position all day. Get up, step away from your desk and do exercises to stretch your arms, shoulders, neck and legs.
8. If you should experience any physical discomfort while using your keypad, such as pain, numbness, or tingling in your hands, wrists, elbows, shoulders, neck or back, please consult a qualified medical doctor immediately.

MAINTENANCE AND USE

The Razer Orbweaver requires minimum maintenance to keep it in optimum condition. Once a month we recommend you unplug the device from the computer and clean it using a soft cloth or cotton swab with a bit of warm water to prevent dirt buildup. Do not use soap or harsh cleaning agents.

9. LEGALESE

COPYRIGHT AND INTELLECTUAL PROPERTY INFORMATION

©2012 Razer Inc. Patent Pending. All Rights Reserved. Razer™, the Razer Triple-Headed Snake logo, the Razer distressed word logo and other trademarks contained herein are trademarks or registered trademarks of Razer Inc. and/or its affiliated or associated companies, registered in the United States and/or other countries. Windows and the Windows logo are trademarks of the Microsoft group of companies. Mac OS, Mac and the Mac logo are trademarks or registered trademarks of Apple.

Razer Inc. (“Razer”) may have copyright, trademarks, trade secrets, patents, patent applications, or other intellectual property rights (whether registered or unregistered) concerning the product in this Master Guide. Furnishing of this Master Guide does not give you a license to any such copyright, trademark, patent or other intellectual property right. The Razer Orbweaver (the “Product”) may differ from pictures whether on packaging or otherwise. Razer assumes no responsibility for such differences or for any errors that may appear. Information contained herein is subject to change without notice.

LIMITED PRODUCT WARRANTY

For the latest and current terms of the Limited Product Warranty, please visit www.razerzone.com/warranty.

LIMITATION OF LIABILITY

Razer shall in no event be liable for any lost profits, loss of information or data, special, incidental, indirect, punitive or consequential or incidental damages, arising in any way out of distribution of, sale of, resale of, use of, or inability to use the Product. In no event shall Razer’s liability exceed the retail purchase price of the Product.

COSTS OF PROCUREMENT

For the avoidance of doubt, in no event will Razer be liable for any costs of procurement unless it has been advised of the possibility of such damages, and in no case shall Razer be liable for any costs of procurement liability exceeding the retail purchase price of the Product.

GENERAL

These terms shall be governed by and construed under the laws of the jurisdiction in which the Product was purchased. If any term herein is held to be invalid or unenforceable, then such term (in so far as it is invalid or unenforceable) shall be given no effect and deemed to be excluded without invalidating any of the remaining terms. Razer reserves the right to amend any term at any time without notice.